



rk steel smith
defining workspace

Industrial Vertical Drawer

Large amount of small parts
(Industrial Hardware A professional organization system)

Cabinet

PRODUCT RANGE

Maximum organization with
Minimum space requirements.....
The tools are always ready-to-hand.....

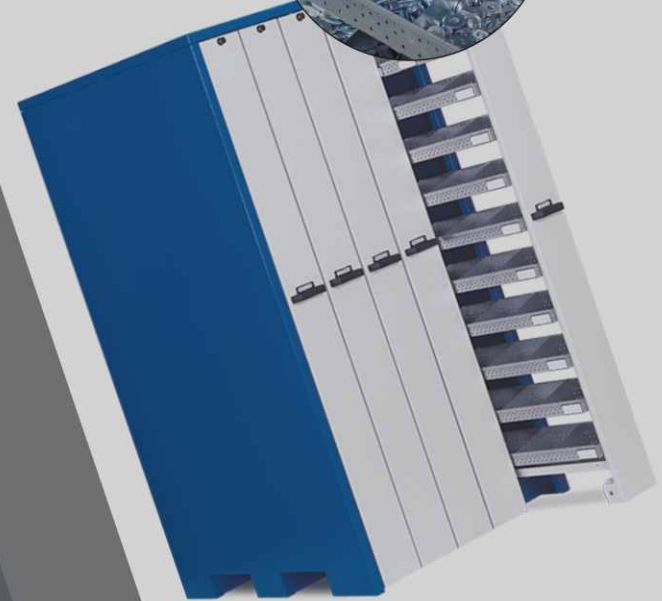
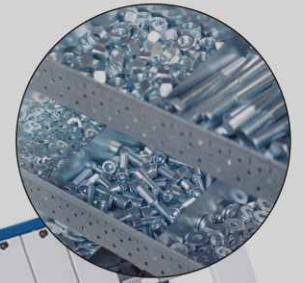

2018

One for all!



Long Tools



CNC Tool

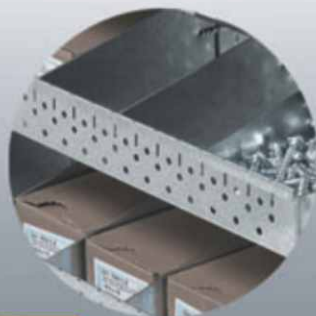

Hardware



Press-brake



Bin



1850mm H.

1250mm H.



Punching Tool



Hardware



Fastner



Die



Safe, functional technology made in India

The RKSS tool cabinets of the VDC series assure maximum organization at minimum space requirements. Thanks to vertical drawers, the tools are always ready-to-hand.

The direct access to the tooling from both sides provides increased safety as reaching over the tools is eliminated.

Integrated transport notches allow the easy relocation of your tool cabinet by lift truck or cart when empty.



small parts Cabinet

05 & 08

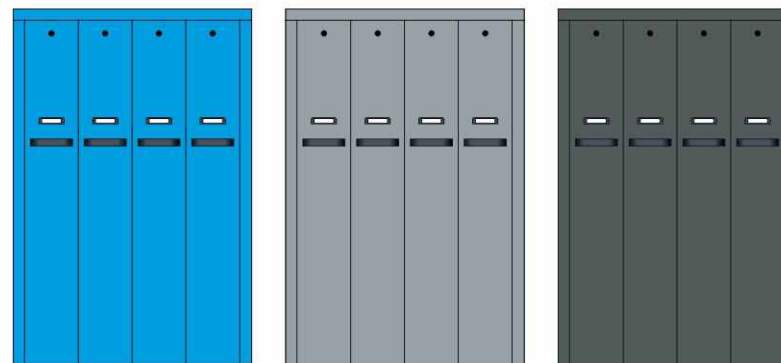

Colour Option

09

Bulk trays – storage with high capacity and flexible division!



1250mm H. X 1100mm D.

1850mm H. X 1100mm D.



Max. load capacity 900kg. each drawer



Relocation by pallet truck **only use for empty cabinet**



Drawers individually lockable

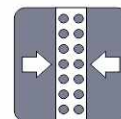

Both - sided access

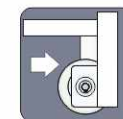

Highest Capacity and reliable guidance the statements by idler wheels



Excerpts separately lockable and with easy to identify labeling field

Storage of large amount of small parts

Direct access to the tooling from both sides provides increased safety as reaching over the tools is eliminated.

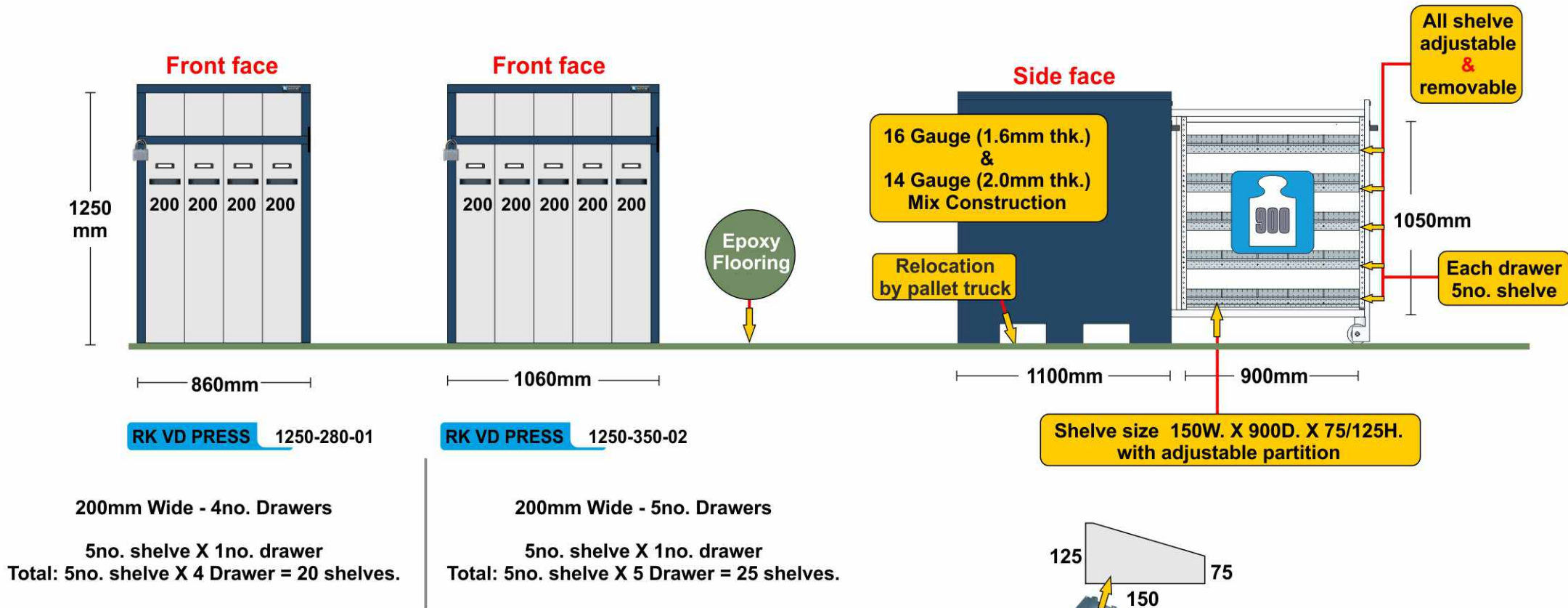

Storage of large amount of small parts

Direct access to the tooling from both sides provides increased safety as reaching over the tools is eliminated.

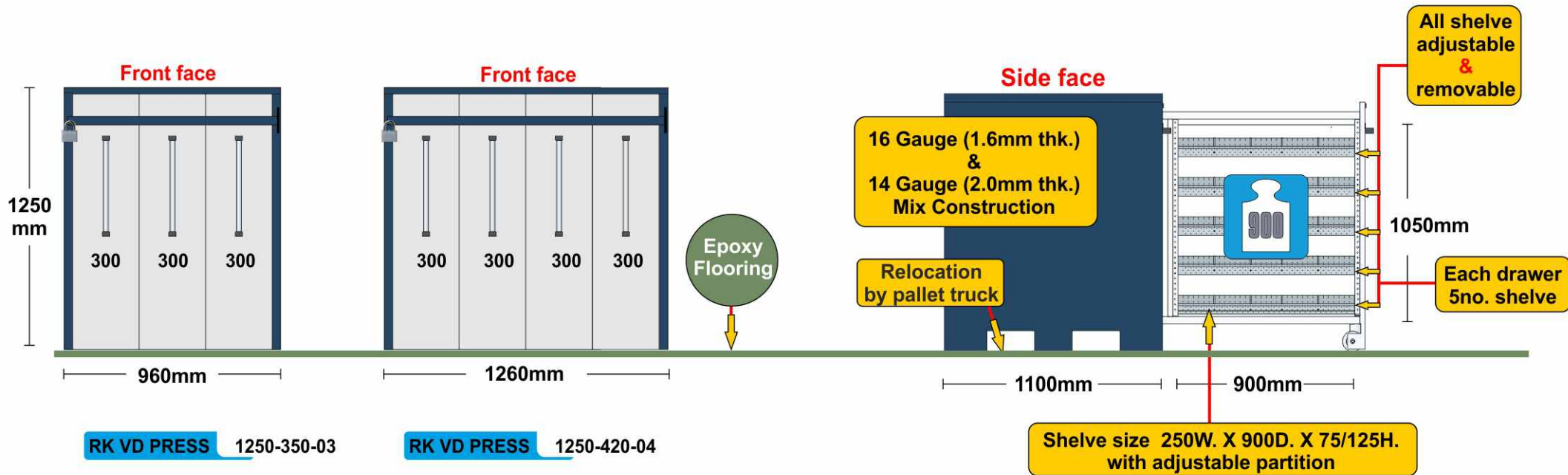

RK VD PRESS 1250-350-03

RK VD PRESS 1250-420-04

300mm Wide - 3no. Drawers

5no. shelf X 1no. drawer

Total: 5no. shelf X 3 Drawer = 15 shelves.

300mm Wide - 4no. Drawers

5no. shelf X 1no. drawer

Total: 5no. shelf X 4 Drawer = 20 shelves.



Direct access to the tooling from both sides provides increased safety as reaching over the tools is eliminated.

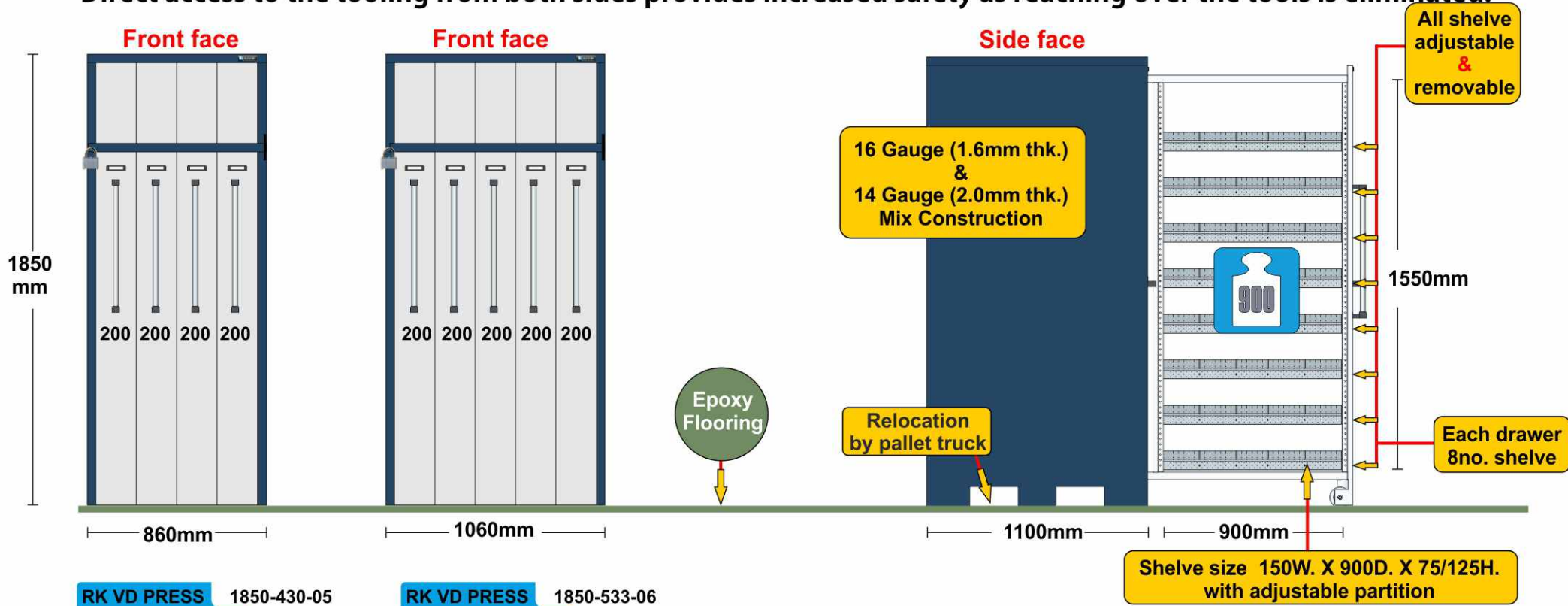

200mm Wide - 4no. Drawers

8no. shelf X 1no. drawer
Total: 8no. shelf X 4 Drawer = 32 shelves.

200mm Wide - 5no. Drawers

8no. shelf X 1no. drawer
Total: 8no. shelf X 5 Drawer = 40 shelves.

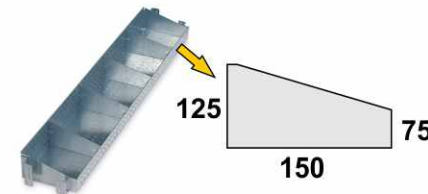

Direct access to the tooling from both sides provides increased safety as reaching over the tools is eliminated.

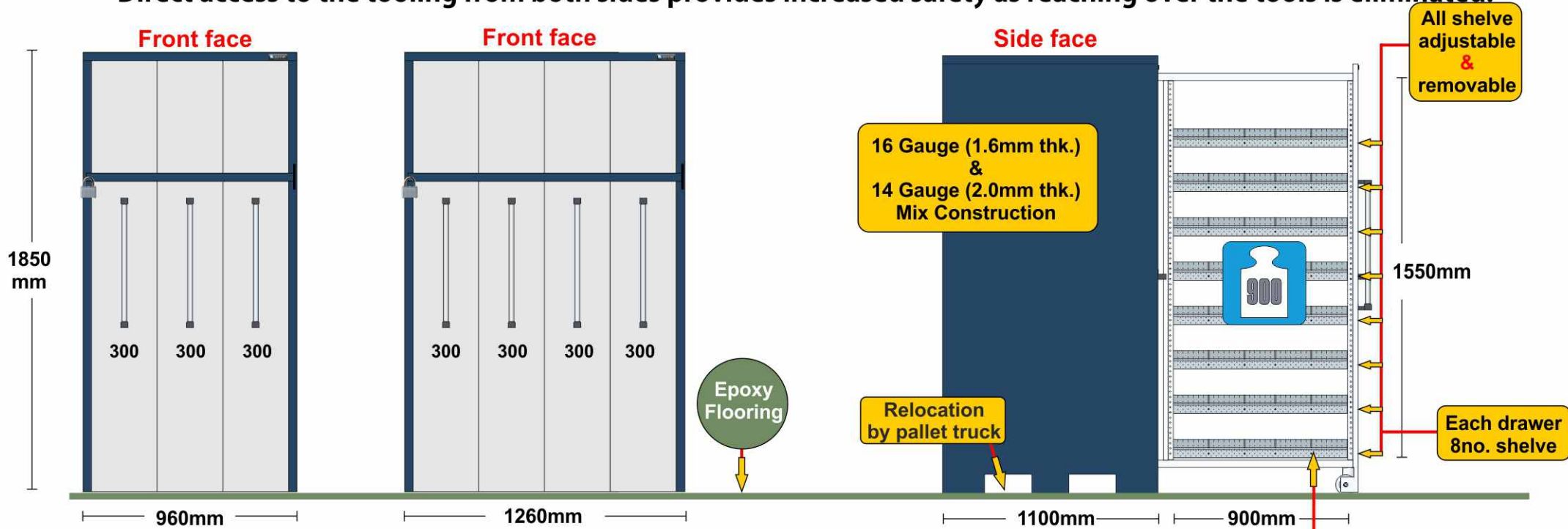

RK VD PRESS 1850-530-07

300mm Wide - 3no. Drawers

8no. shelf X 1no. drawer

Total: 8no. shelf X 3 Drawer = 24 shelves.

RK VD PRESS 1850-633-08

300mm Wide - 4no. Drawers

8no. shelf X 1no. drawer

Total: 8no. shelf X 4 Drawer = 32 shelves.

Shelf size 250W. X 900D. X 75/125H. with adjustable partition

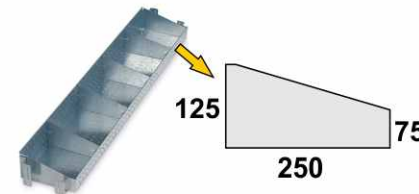

Standard Color option :



7035
Pale Grey - Str.

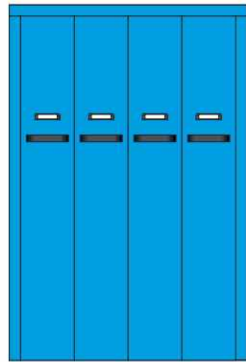

5015
American Blue - Str.



6009
D. A. Grey - Str.



5013
PP Dark Grey - Str.



3001
Red - Str.

Assembled components are transfer to pre-treatment plant for treating in 7 tank for degrees, zinc, phosphating and passivation.

Material received from pre-treatment department are immediately powder coated in the dust free painting booth and then the articles are put inside a baking oven at a temperature of 180° C for about 20 minutes.



rk steel smith
defining workspace



Plot- B/32 (Part-2) Bileshwar Indl. Estate,
Opp. G.V.M.M.,
Odhav-Kathwada Road,
Ahmedabad - 382415
Gujarat (INDIA).



+91 94 281 35 100
+91 98 253 00 059



rksteelsmith@gmail.com
info@rksteelsmith.com
sales@rksteelsmith.com



www.rksteelsmith.com